



User Manual

PCE-CS xxxxLD Crane Scales



User manuals in various languages (français, italiano, español, português, nederlands, türk, polski, русский, 中文) can be found by using our product search on: www.pce-instruments.com

Last change: 31 August 2022
v1.0



Contents

1	Safety notes	1
2	Specifications	2
3	Delivery scope	2
4	Dimensions	3
5	Device description	4
5.1	Remote control	7
5.2	Display description	8
5.3	Indications	8
6	Operation	8
6.1	Switch scales on and off	8
6.2	Zero point	9
6.3	Taring	9
6.4	Hold function	9
6.5	Totalising weights (accumulation)	9
6.6	Change unit	10
7	Settings	10
7.1	Advanced settings	11
7.2	Adjustment	13
8	Battery	14
9	Contact	14
10	Disposal	14

1 Safety notes

Please read this manual carefully and completely before you use the device for the first time. The device may only be used by qualified personnel and repaired by PCE Instruments personnel. Damage or injuries caused by non-observance of the manual are excluded from our liability and not covered by our warranty.

- The device must only be used as described in this instruction manual. If used otherwise, this can cause dangerous situations for the user and damage to the meter.
- The instrument may only be used if the environmental conditions (temperature, relative humidity, ...) are within the ranges stated in the technical specifications. Do not expose the device to extreme temperatures, direct sunlight, extreme humidity or moisture.
- Do not expose the device to shocks or strong vibrations.
- The case should only be opened by qualified PCE Instruments personnel.
- Never use the instrument when your hands are wet.
- You must not make any technical changes to the device.
- The appliance should only be cleaned with a damp cloth. Use only pH-neutral cleaner, no abrasives or solvents.
- The device must only be used with accessories from PCE Instruments or equivalent.
- Before each use, inspect the case for visible damage. If any damage is visible, do not use the device.
- Do not use the instrument in explosive atmospheres.
- The measurement range as stated in the specifications must not be exceeded under any circumstances.
- Since lifting loads is associated with hazards, certain obligations must be fulfilled by the manufacturer as well as the user in order to prevent these hazards. The use of the measuring equipment must not constitute a hazard at any time.
- The permissible nominal loads [MAX] of the test equipment and other means used (e. g. crane, load sling, etc.) must not be exceeded under any circumstances.
- When not in use, no loads must be attached to the scales.
- Before using the scales, make sure that all brackets are firmly mounted.
- Make sure that there are no persons under the suspended load.
- The measuring device is only permitted for lifting and weighing freely moving loads. Twisting the load (torsional stress) is not permitted. Transporting persons, pulling loads at an angle, tearing them loose, dragging them etc. is prohibited.
- Installation, commissioning, maintenance and operation of the measuring equipment may only be carried out by trained persons wearing appropriate protective equipment.
- Never touch the moving parts during the weighing process. This can lead to injuries.
- Do not enter the danger zone during use. This does not only include the area directly below the load but also areas that could become a hazard, e. g. due to swinging ropes or other load suspension equipment.
- Non-observance of the safety notes can cause damage to the device and injuries to the user.

We do not assume liability for printing errors or any other mistakes in this manual.

We expressly point to our general guarantee terms which can be found in our general terms of business.



2 Specifications

PCE-CS 300LD	
Measurement range	0 ... 300 kg / 0 ... 661 lbs
Minimum load	2 kg / 4.4 lbs
Resolution	0.05 kg / 0.1 lbs
Accuracy	1 % of range
PCE-CS 500LD	
Measurement range	0 ... 500 kg / 0 ... 1102 lbs
Minimum load	4 kg / 8.8 lbs
Resolution	0.1 kg / 0.2 lbs
Accuracy	1 % of range
PCE-CS 1000LD	
Measurement range	0 ... 1000 kg / 0 ... 2205 lbs
Minimum load	10 kg / 22 lbs
Resolution	0.2 kg / 0.4 lbs
Accuracy	1 % of range
Further specifications	
Additional functions	totalising function, user-defined unit
Tare range	100 % of range
Zero point range	4 % of range
Units	kg, lb, un (user defined)
Digit height	41 mm / 1.6"
Automatic power off of the backlight	after 30 seconds of inactivity reactivation after pressing a key or when the weight is changed
Power supply crane scales	4 x 1.5 V AA battery
Power supply remote control	2 x 1.5 V AA battery
Operating conditions	5 ... 35 °C / 41 ... 95 °F <90 % RH, non-condensing
Weight	1300 g / 2.9 lbs

3 Delivery scope

- 1 x PCE-CS xxxxLD crane scales
- 1 x remote control
- 6 x 1.5 V AA battery
- 1 x user manual

4 Dimensions

Letter	Length in mm
A	290
B	23

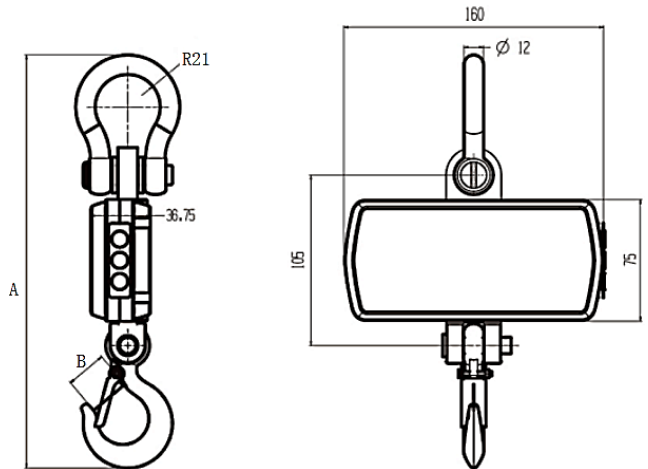

5 Device description



No.	Description
1	Shackle
2	Display
3	Hook

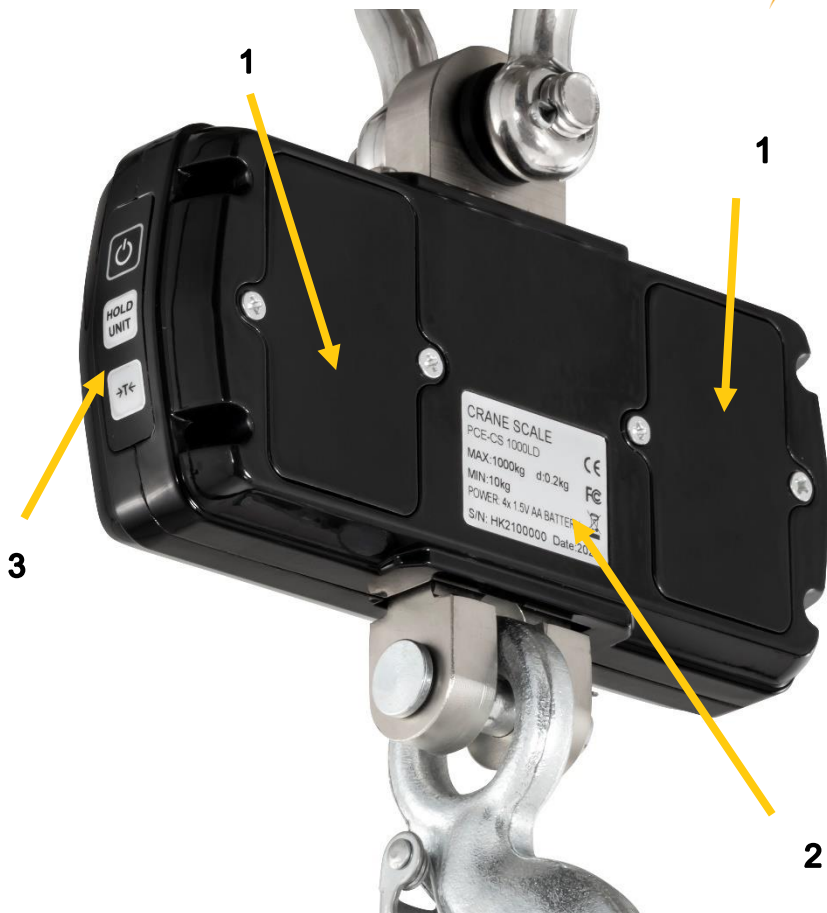

No.	Description
1	Battery compartments
2	Nameplate
3	Keypad



No.	Function
1	Press: cancel or return to weighing mode Press and hold: switch on and off
2	Press: freeze display Press and hold: change unit
3	Press: tare / disable taring Press and hold: zero point

5.1 Remote control

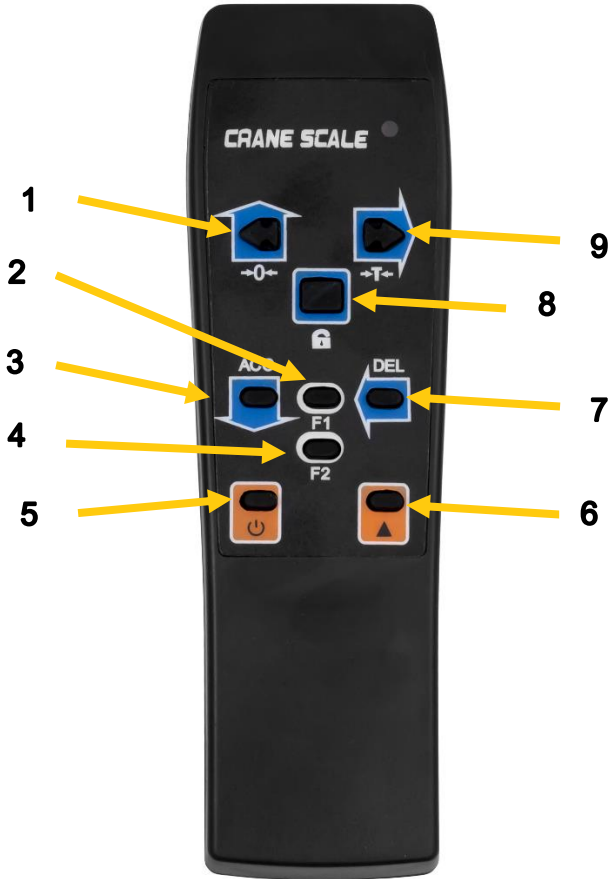

No.	Description
1	Zero point, increase value
2	Totaliser function view
3	Totalised weight, decrease value
4	Change unit
5	Press: back to weighing mode Press and hold: switch off the scales
6	Secondary function level
7	Delete last weight, go one step to the left
8	Freeze display, accept entry, confirm entry
9	Tare / disable taring, go one step to the right

5.2 Display description

Possible display	Meaning
STB	Displayed measured value is stable
Zero	Displayed measured value is the zero point
Tara	Displayed measured value is tared
HOLD	Displayed measured value is frozen
lb	Measured value in pounds
kg	Measured value in kilogrammes
UN	Measured value is displayed in a user-defined unit

5.3 Indications

Possible display	Meaning
- - - -	Weight detected
Setup	Settings
Bat99	Battery indicator in per cent
End	Save and return
oFF	Shutdown
ouEr	Overrange
Err	Invalid action
ACC	Totalising (accumulation)
DEL	Delete data
CLR	Delete all data



6 Operation

6.1 Switch scales on and off

To switch on the scales, press and release the  key once. The scales are powered on and a start-up process begins.

- "8.8.8.8." flashes twice
- maximum capacity display
- display of the battery level in per cent
- measurement begins



If - - - is displayed during the start-up process, a weight has been detected and must be removed.

To switch off the scales, press and hold the  key on the remote control for about one second or press the  key on the scales. The scales are switched off with the following display:

- Display of the battery level in per cent
- oFF
- The scale is now switched off



Note: It is not possible to switch on the scales via the remote control. When the total battery voltage is 3.75 V, the scales are switched off automatically because the battery voltage is too low.

6.2 Zero point

To set the zero point, press the  key on the remote control or hold down the  key on the scales.



Note: If the attached load is in motion, tared or outside the manual zero range, "Err" is displayed.

6.3 Taring

To tare the weight, press the  key on the remote control or press and release the  key on the scales once. To delete the tared weight, press the key again.

Note: If the suspended load is in motion, negative or out of the tare range, "Err" is displayed.

6.4 Hold function



To freeze the display, press the  key on the remote control or the  key on the scales. The display will also show "HOLD" next to the held reading. To resume the measurement, press the key again.

6.5 Totalising weights (accumulation)

Press the  key on the remote control to add up the displayed weight. Once the value has been accepted, "ACC" is briefly displayed once.

Note: If the suspended load is not stable, negative or the load has not been suspended, "Err" is displayed.

6.5.1 Display the total weight

To display the sum of the weights, press and release the F1 key on the remote control once. The total is displayed flashing. Press the  key on the remote control to display the highest or lowest totalised value. To return to measuring mode, press and release the  key once.

Note: It is not possible to add further values in this view. To do this, you must go back to measuring mode.

6.5.2 Delete last measured value

Press the  key on the remote control to delete the last totalised value. If "dEL" is displayed, the last value has been deleted.

Note: Only the last value can be deleted.

6.5.3 Delete all saved values



To delete all saved values, first press the  key on the remote control and then press the  key.





As soon as "CLR" is shown on the display, all values are deleted.

6.6 Change unit



To set the unit, press the F2 key on the remote control or briefly press and hold the  key on the scales. You can choose kg, lb or un.

7 Settings

To make settings to the scales, the remote control is mandatory. To open the settings menu, first press the  key and then the  key. "SETUP" is displayed.

Now select the desired menu item with the  key. Use the  and  keys to change the value. Press the  key again to accept the change.

Menu structure



Display	Function	Possible settings
	Here you can set the time after which the scales switch off automatically in case of inactivity.	0 = off (default) 5 = 5 minutes 10 = 10 minutes 15 = 15 minutes 30 = 30 minutes 60 = 60 minutes
	The brightness of the backlight can be set here.	Off = off 1 = dimmed 2 = normal 3 = bright
	Here you can set the time during which the backlight is active.	0 = off 5 = 5 seconds 10 = 10 seconds 15 = 15 seconds 30 = 30 seconds (default) 60 = 60 seconds
End	You have reached the end of the menu.	No settings possible. The scales automatically return to weighing mode.

7.1 Advanced settings





Note:

The advanced settings should only be used by advanced users as incorrect parameterisation can cause problems.

Changing the parameters does not change the given specifications.

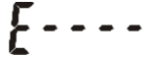
To open the advanced settings, press the  key twice. "P0000" is then displayed. Use the arrow keys on the remote control to enter the password P0258 and confirm the entry with the  key. The scales now display "SCALE". The operation of the advanced settings is identical to the operation of the normal settings.

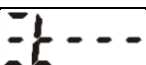
Menu structure



Display	Function	Possible settings
	The display resolution can be set here.	0.001 / 0.002 / 0.005 / 0.01 / 0.02 / 0.05 / 0.1 / 0.2 / 0.5 / 1 / 2 / 5 / 10 / 20 / 50
	The automatic zero point range can be set here.	0 = off 2 = ± 2 % of range 3 = ± 3 % of range 4 = ± 4 % v. range 10 = ± 10 % of range 20 = ± 20 % of range (default) 100 = ± 100 % of range
	The manual zero point range can be set here.	0 = off 2 = ± 2 % of range 3 = ± 3 % of range 4 = ± 4 % v. range (default) 10 = ± 10 % of range 20 = ± 20 % of range 100 = ± 100 % of range
	The zero tracking range can be set here. This function can help to maintain accuracy in the event of temperature fluctuations.	0.0 = off 0.5 = $\pm 0.5e$ (default) 1.0 = $\pm 1.0e$ 1.5 = $\pm 1.5e$ 2.0 = $\pm 2.0e$ 2.5 = $\pm 2.5e$ 3.0 = $\pm 3.0e$ 3.5 = $\pm 3.5e$ 4.0 = $\pm 4.0e$ 4.5 = $\pm 4.5e$ 5.0 = $\pm 5.0e$
	The zero point range can be set here. This function defines the range in which the measured value must be lower than the set value before a measurement is possible.	0.0 = off 0.5 = $\pm 0.5e$ 1.0 = $\pm 1.0e$ 1.5 = $\pm 1.5e$ 2.0 = $\pm 2.0e$ 2.5 = $\pm 2.5e$ 3.0 = $\pm 3.0e$ 3.5 = $\pm 3.5e$ 4.0 = $\pm 4.0e$ 4.5 = $\pm 4.5e$ 5.0 = $\pm 5.0e$ (default)









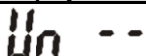

5E---	This function measures the weight based on the last zeroing. When this function is active, automatic zeroing is deactivated.	On = switched on Off = switched off (default)
5t6 -	Here you can set the measuring rate. If the weight is unstable, a high value should be selected. If the attached weight is stable, a low value can be selected.	0 = off 1 = weakest (default) 2 = weak 3 = normal 4 = strong 5 = strongest
dy---	Dynamic weighing can be enabled here. If the weighing accuracy is of secondary importance and the speed of a measurement is crucial, the "STB" function can be permanently activated here.	On = on Off = off (default)
G-----	Here you set the gravitational value of the place of use after a calibration.	0000 ... 9999 You can change the value with the arrow keys on the remote control. You can move the decimal point with the F1 key.
U-----	Here you can store your own unit via a factor.	0000 ... 9999 You can change the value with the arrow keys on the remote control. You can move the decimal point with the F1 key.

7.2 Adjustment

If the scales show incorrect values, it can be adjusted. An adjustment should only be carried out by an advanced user. Make sure in advance that you have calibrated weights available to achieve an accurate result.

Note: Changing parameters does not change the specifications.

To open the adjustment menu, press the  key twice. "P0000" is then displayed. Enter the password P8416 using the arrow keys on the remote control and confirm the entry with the  key. The scales now display "CAL". The operation of the advanced settings is identical to the operation of the normal settings.

Display	Function	Possible settings
	Here you can set the unit with which the calibration is to be carried out.	kg, lb
	Here you set the gravitational value of the calibration location.	0000 ... 9999 You can change the value with the arrow keys on the remote control. You can move the decimal point with the F1 key.
	The maximum capacity can be set here.	0000 ... 9999 You can change the value with the arrow keys on the remote control. You can move the decimal point with the F1 key.
	Here you set the zero point.	Then press the  key. Let the scales hang freely and wait until the displayed digit value has stabilised. Then press the  key.
	Here you can set the first calibration point.	00000 ... 99999 You can change the value with the arrow keys on the remote control. You can set the decimal point with the F1 key. Then press the  key to accept the value. The digit value is now displayed. Attach the set weight and wait until the value has stabilised. Then press the  key.
	Here you can set the second calibration point.	See previous step.
	Here you can set the third calibration point	See previous step. You have now completed the calibration and the scales return to weighing mode.



8 Battery

The battery status is displayed each time the scales are switched on and off. As soon as the batteries are flat, they must be replaced with new ones. For battery replacement, there are two battery compartments on the back of the scales that can be opened with a screwdriver. Two 1.5 V AA batteries must be inserted in each battery compartment. Ensure correct polarity. After inserting the batteries, the battery compartment must be closed. The scales can then be used again.

There is an LED on the remote control. It should flash when a key is pressed. If it does not flash, the batteries are probably flat and need to be replaced. The battery compartment is on the back. Use two 1.5 V AA batteries. Ensure correct polarity when inserting them.

9 Contact

If you have any questions, suggestions or technical problems, please do not hesitate to contact us. You will find the relevant contact information at the end of this user manual.

10 Disposal

For the disposal of batteries in the EU, the 2006/66/EC directive of the European Parliament applies. Due to the contained pollutants, batteries must not be disposed of as household waste. They must be given to collection points designed for that purpose.

In order to comply with the EU directive 2012/19/EU we take our devices back. We either re-use them or give them to a recycling company which disposes of the devices in line with law.

For countries outside the EU, batteries and devices should be disposed of in accordance with your local waste regulations.

If you have any questions, please contact PCE Instruments.



PCE Instruments contact information

Germany

PCE Deutschland GmbH
Im Langel 26
D-59872 Meschede
Deutschland
Tel.: +49 (0) 2903 976 99 0
Fax: +49 (0) 2903 976 99 29
info@pce-instruments.com
www.pce-instruments.com/deutsch

United Kingdom

PCE Instruments UK Ltd
Unit 11 Southpoint Business Park
Ensign Way, Southampton
Hampshire
United Kingdom, SO31 4RF
Tel: +44 (0) 2380 98703 0
Fax: +44 (0) 2380 98703 9
info@pce-instruments.co.uk
www.pce-instruments.com/english

The Netherlands

PCE Brookhuis B.V.
Institutenweg 15
7521 PH Enschede
Nederland
Telefoon: +31 (0)53 737 01 92
info@pcebenelux.nl
www.pce-instruments.com/dutch

France

PCE Instruments France EURL
23, rue de Strasbourg
67250 Soultz-Sous-Forets
France
Téléphone: +33 (0) 972 3537 17
Numéro de fax: +33 (0) 972 3537 18
info@pce-france.fr
www.pce-instruments.com/french

Italy

PCE Italia s.r.l.
Via Pesciatina 878 / B-Interno 6
55010 Loc. Gragnano
Capannori (Lucca)
Italia
Telefono: +39 0583 975 114
Fax: +39 0583 974 824
info@pce-italia.it
www.pce-instruments.com/italiano

United States of America

PCE Americas Inc.
1201 Jupiter Park Drive, Suite 8
Jupiter / Palm Beach
33458 FL
USA
Tel: +1 (561) 320-9162
Fax: +1 (561) 320-9176
info@pce-americas.com
www.pce-instruments.com/us

Spain

PCE Ibérica S.L.
Calle Mayor, 53
02500 Tobarra (Albacete)
España
Tel. : +34 967 543 548
Fax: +34 967 543 542
info@pce-iberica.es
www.pce-instruments.com/espanol

Turkey

PCE Teknik Cihazları Ltd.Şti.
Halkalı Merkez Mah.
Pehlivan Sok. No.6/C
34303 Küçükçekmece - İstanbul
Türkiye
Tel: 0212 471 11 47
Faks: 0212 705 53 93
info@pce-cihazlari.com.tr
www.pce-instruments.com/turkish

Denmark

PCE Instruments Denmark ApS
Birk Centerpark 40
7400 Herning
Denmark